

## REFRIGERATION SECTION

26504

2.292 kg/m

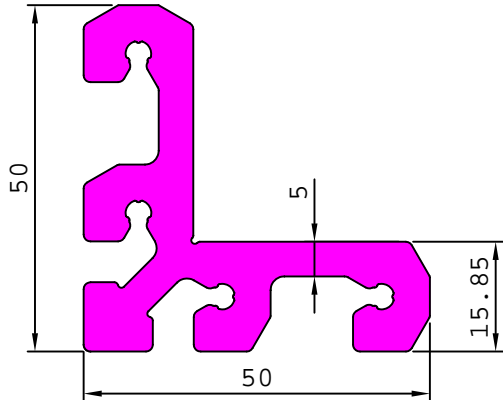

26823

1.268 kg/m

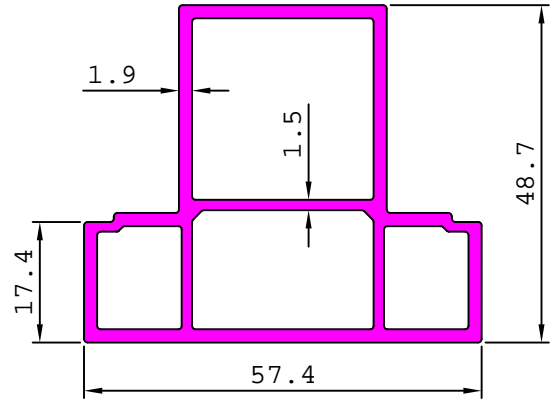

26839

0.717 kg/m

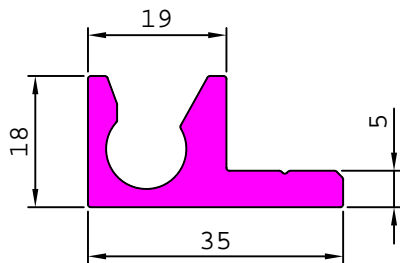

26840

0.886 kg/m

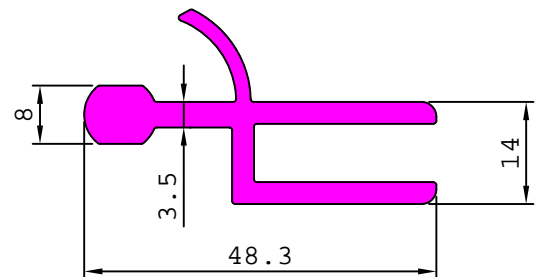

26849

0.850 kg/m

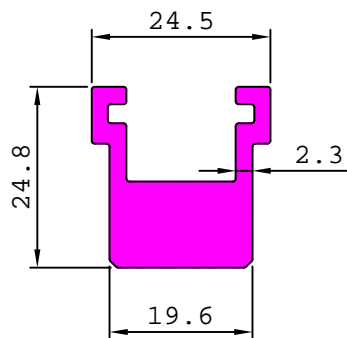

26850

1.327 kg/m

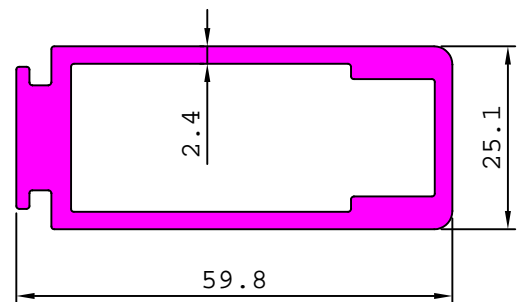

26851

1.078 kg/m

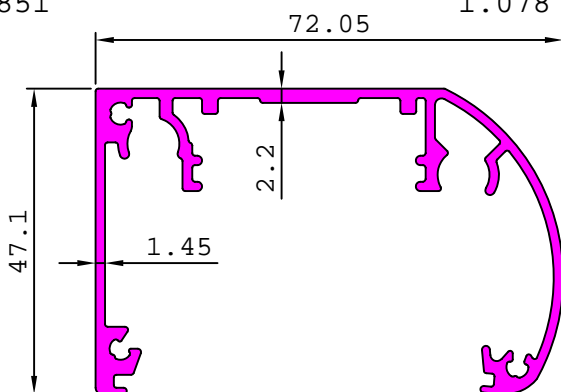

26857

0.526 kg/m

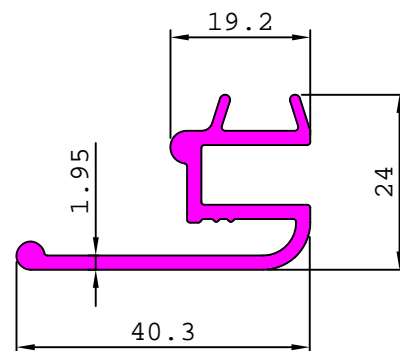

## REFRIGERATION SECTION

26874

0.347 kg/m

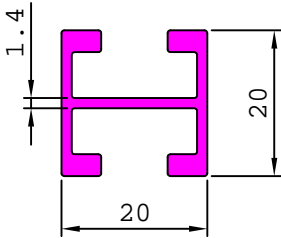

26923

0.084 kg/m

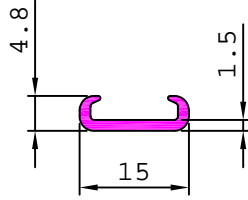

26921

0.124 kg/m

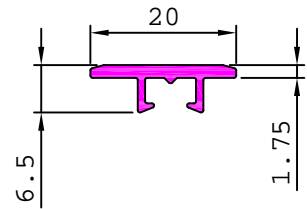

26876

1.050 kg/m

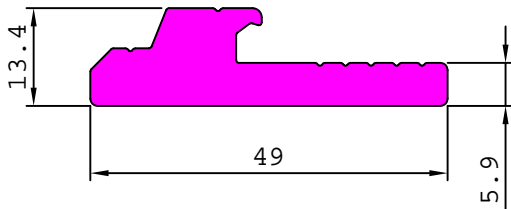

26878

0.429 kg/m

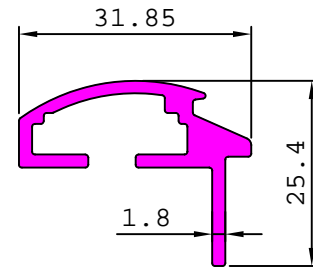

26877

0.783 kg/m

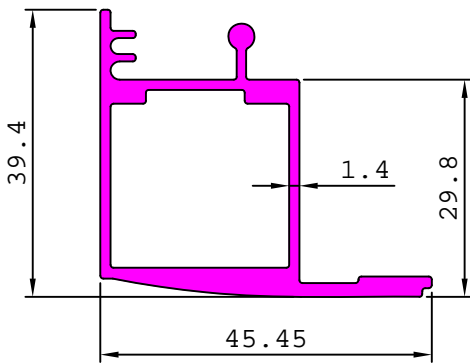

26879

0.795 kg/m

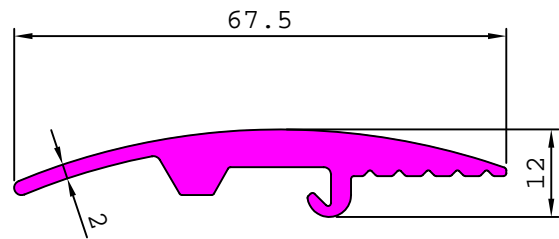

26880

0.897 kg/m

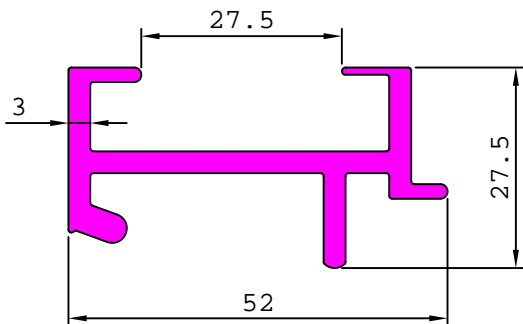

26894

0.656 kg/m

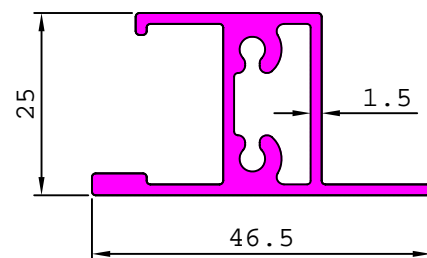

## REFRIGERATION SECTION

26914

2.479 kg/m

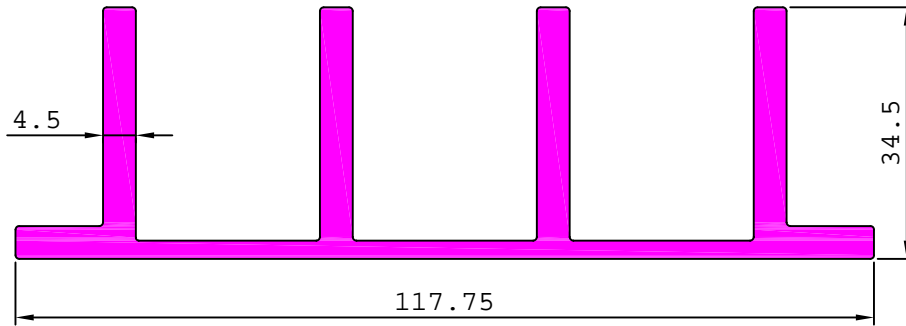

26916

1.489 kg/m

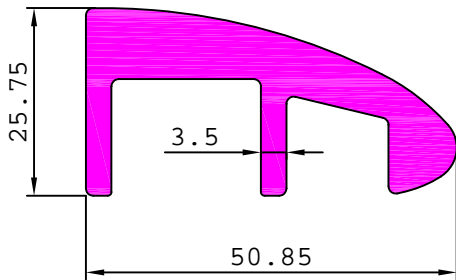

26915

0.995 kg/m

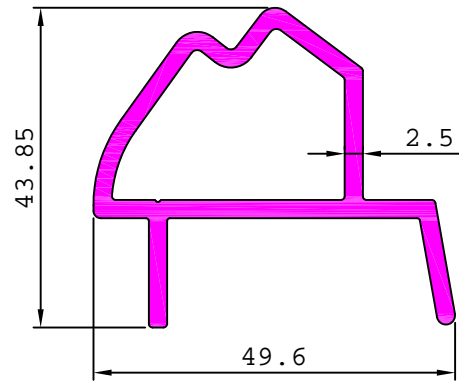

26918

0.770 kg/m

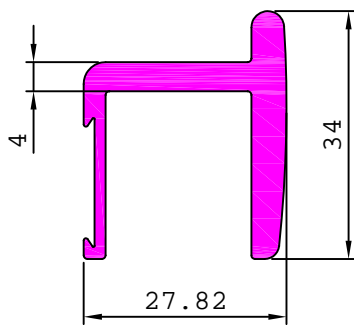

26919

2.410 kg/m

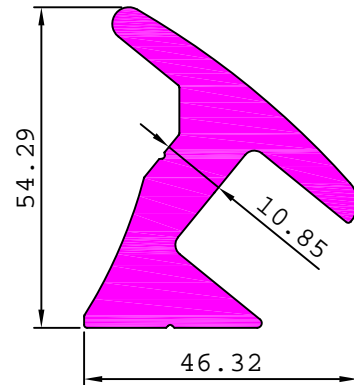

26920

0.974 kg/m

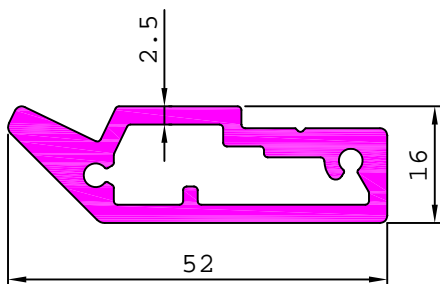

26917

0.818 kg/m

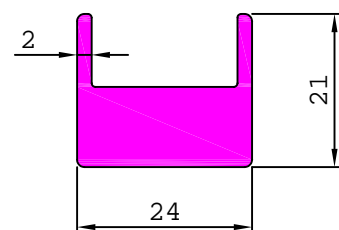

**REFRIGERATION SECTION**

26922

1.060 kg/m

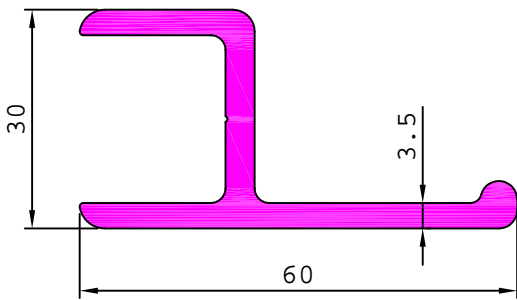

26926

0.760 kg/m

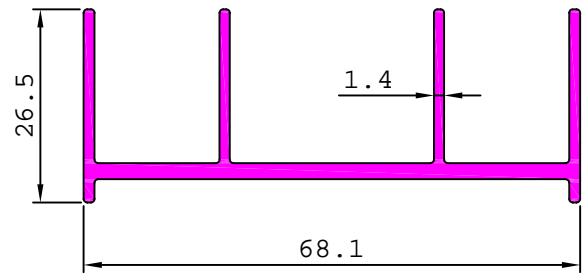

26924

11.619 kg/m

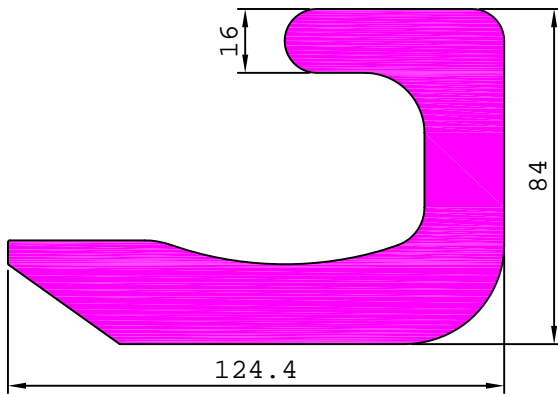

26927

0.561 kg/m

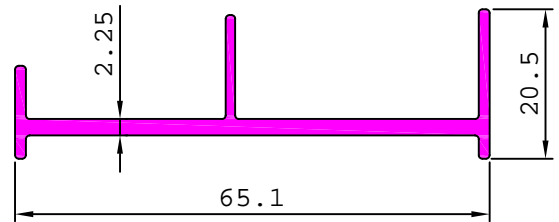

26928

0.561 kg/m

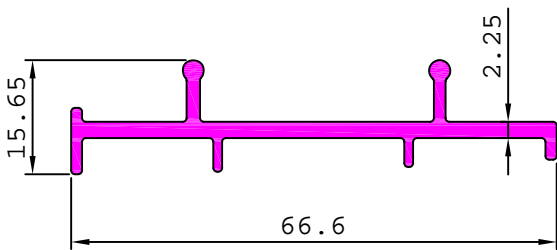

26929

0.709 kg/m

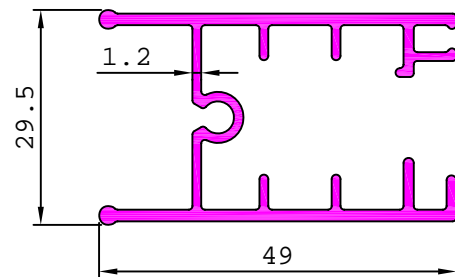

26930

0.344 kg/m

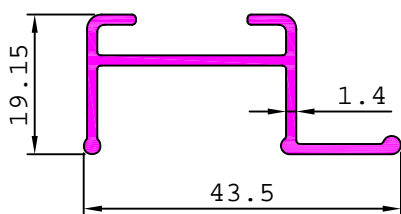

26931

0.279 kg/m

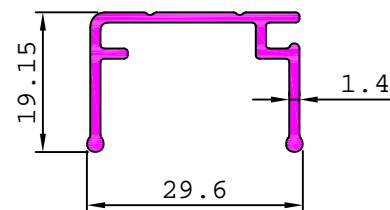

**REFRIGERATION SECTION**

26934

0.377 kg/m

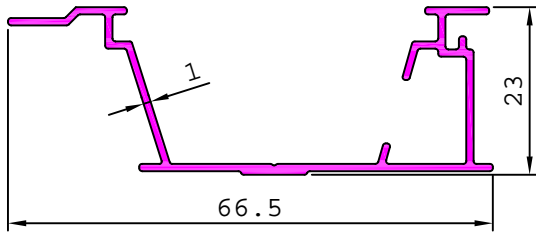

26932

0.510 kg/m

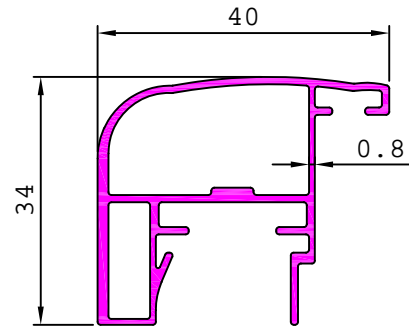

26933

0.673 kg/m

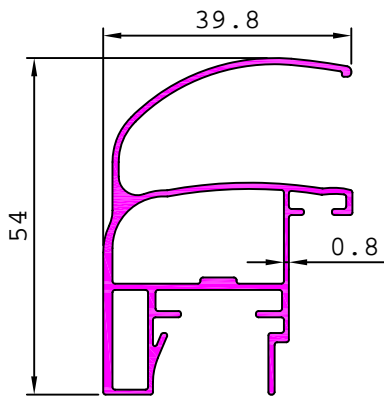

26935

0.949 kg/m

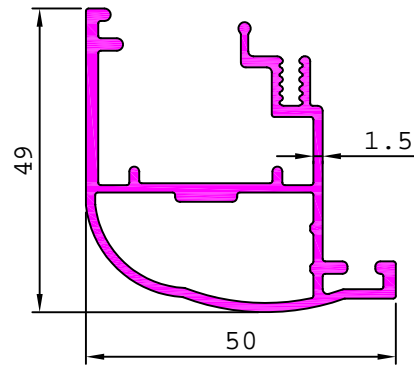

26936

0.658 kg/m

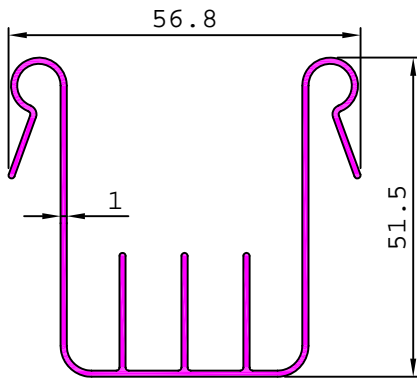

26983

1.789 kg/m

