

TOWER BOLT

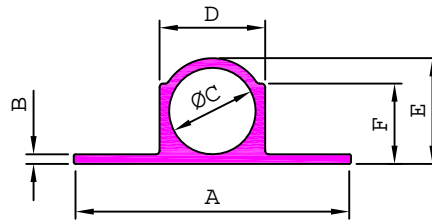

Sl No	Section No	A	B	ØC	D	E	F	Weight kg/m
1	18001	24.50	0.75	8.63	10.10	10.10	8.15	0.121
2	18002	31.75	1.39	9.90	12.45	12.45	9.52	0.248
3	18003	32.00	1.60	11.00	14.00	14.00	11.00	0.302
4	18005	31.75	1.52	10.28	12.82	12.82	9.52	0.253
5	18007	44.00	2.00	13.00	17.00	17.00	13.00	0.493
6	18008	30.00	0.75	9.90	11.40	11.40	9.50	0.156
7	18009	25.00	1.35	8.50	11.00	11.20	9.00	0.202
8	18013	37.50	1.70	12.40	15.70	15.80	12.00	0.379
9	18015	31.75	1.70	10.20	12.40	12.40	9.70	0.244
10	18016	38.00	2.30	12.60	17.10	17.10	13.00	0.506
11	18017	31.20	1.57	9.70	11.90	11.90	9.10	0.229
12	18022	30.75	1.02	9.50	11.30	11.30	9.00	0.176
13	18023	31.75	1.10	10.20	12.10	12.10	9.50	0.197
14	18027	37.50	2.00	12.80	16.50	16.50	13.50	0.439
15	18029	37.00	2.20	12.00	15.00	15.50	11.70	0.396
16	18036	36.00	1.85	12.00	14.90	14.90	11.00	0.342
17	18037	30.00	0.98	9.50	10.90	10.90	8.60	0.150
18	18038	44.00	2.00	13.40	16.40	16.50	14.50	0.450
19	18039	32.00	1.25	11.00	13.40	13.40	10.50	0.246
20	18040	37.00	1.83	12.00	15.00	15.00	11.70	0.354
21	18042	23.50	0.70	8.50	9.80	9.80	7.95	0.109
22	18043	28.00	0.59	9.50	10.68	10.68	8.00	0.113
23	18045	32.00	1.30	11.00	13.60	13.60	10.80	0.262
24	18049	38.00	2.35	13.00	17.50	17.50	13.20	0.520
25	18051	31.00	1.10	9.40	11.40	11.40	8.70	0.188
26	18052	31.50	1.20	10.80	12.80	12.80	10.10	0.216
27	18055	31.75	1.40	10.20	12.40	12.40	9.10	0.226
28	18056	31.20	1.35	9.70	11.70	11.70	9.00	0.206
29	18057	38.00	1.90	12.60	16.20	16.20	12.60	0.418
30	18060	44.00	1.65	12.80	15.80	15.80	13.80	0.406
31	18062	32.00	1.22	11.00	13.44	13.40	10.80	0.248
32	18068	31.75	2.00	10.20	12.40	12.40	9.70	0.261
33	18069	31.50	1.55	10.80	12.70	12.70	10.00	0.227
34	18070	31.50	1.40	10.80	12.60	12.60	10.00	0.214
35	18071	31.00	1.40	10.80	12.20	12.20	9.60	0.189
36	18074	36.00	1.40	11.00	12.50	12.50	9.40	0.213
37	18075	36.00	1.70	12.00	13.90	13.90	10.50	0.267
38	18079	30.00	1.45	9.50	11.00	11.30	9.20	0.191
39	18084	30.15	1.20	9.60	11.30	11.30	8.30	0.176
40	18085	37.00	1.90	12.40	14.60	14.60	11.50	0.312
41	18088	31.00	1.05	10.50	11.80	11.80	9.40	0.163

TOWER BOLT

18019

0.255 kg/m

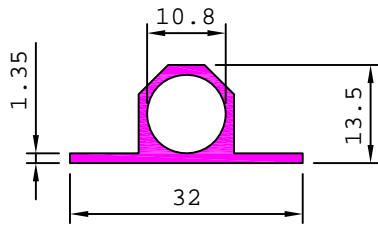

18077

0.340 kg/m

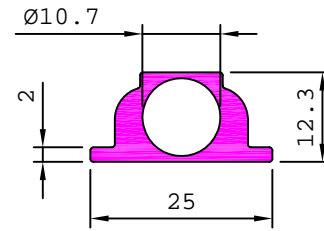

18080

0.520 kg/m

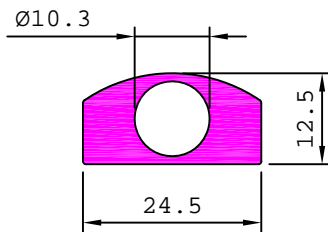

18081

0.225 kg/m

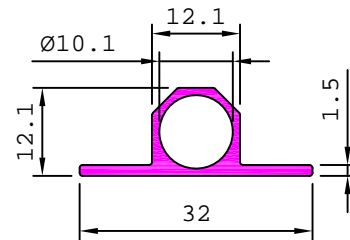

18082

0.458 kg/m

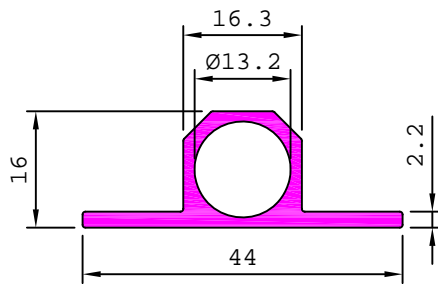

18086

0.306 kg/m

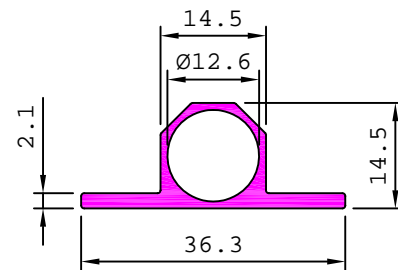

18091

0.295 kg/m

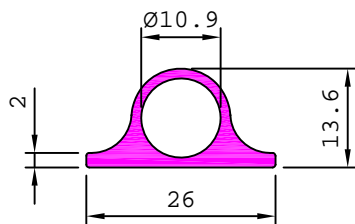

TOWER BOLT

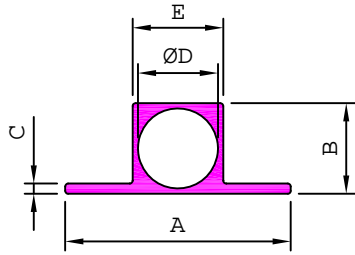

Sl No	Section No	A	B	C	ØD	E	Weight kg/m
1	18065	37.15	14.85	1.60	12.30	15.15	0.381
2	18066	31.00	12.40	0.90	11.00	12.40	0.203
3	18067	31.00	12.00	0.80	10.75	12.00	0.184
4	18076	31.00	12.45	1.40	11.00	12.45	0.232
5	18087	31.00	12.10	1.20	10.60	12.10	0.218
6	18089	37.15	14.50	1.30	12.30	14.50	0.326
7	18090	37.00	14.85	1.50	12.60	14.80	0.346

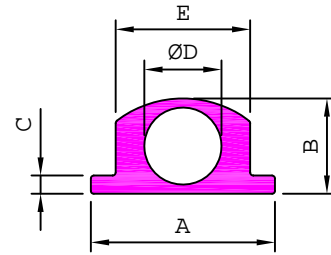

Sl No	Section No	A	B	C	ØD	E	Weight kg/m
1	18063	25.30	13.10	2.50	10.60	18.50	0.411
2	18064	25.00	12.80	2.00	10.60	17.50	0.361
3	18078	25.00	12.80	1.80	10.60	14.20	0.281
4	18083	25.30	13.30	2.30	10.60	14.60	0.326

SPECIAL HINGES

HINGES - HOLLOW

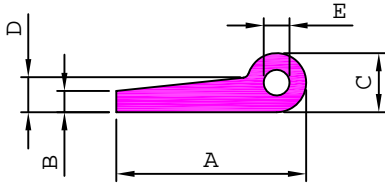

SL. No.	Section No.	A	B	C	D	E	Weight kg/m
1	18361	24.30	2.10	6.00	2.60	3.60	0.170
2	18353	35.76	3.10	9.52	3.60	5.00	0.390
3	18355	37.00	4.00	11.00	4.76	5.55	0.515

18357

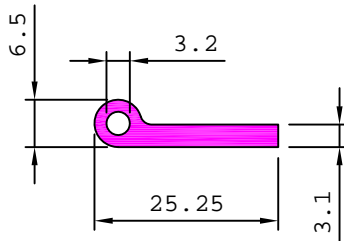

0.231 kg/m

18362

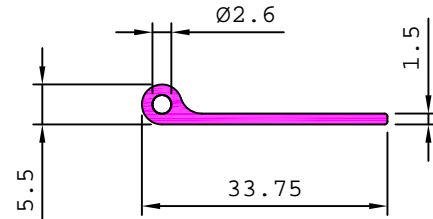

0.172 kg/m

18401

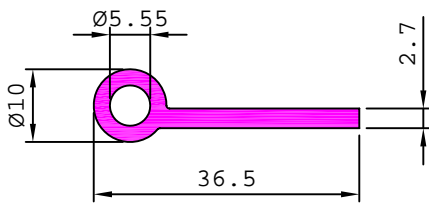

0.343 kg/m

18402

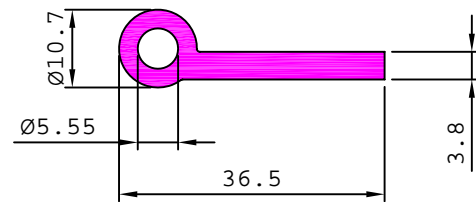

0.450 kg/m

18406

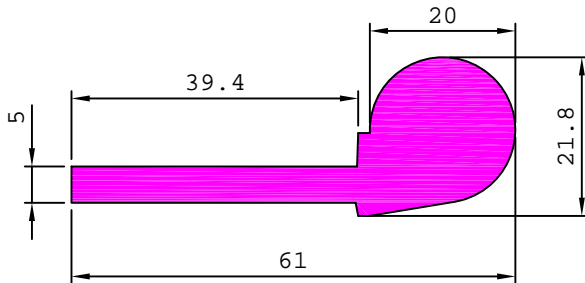

1.515 kg/m

18407

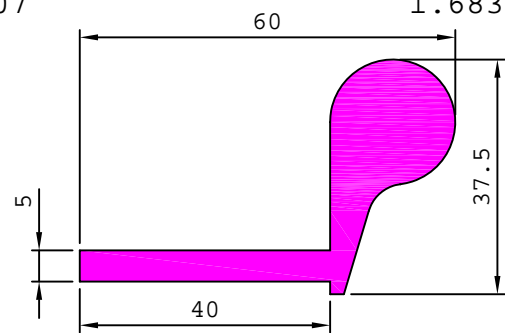

1.683 kg/m

18425

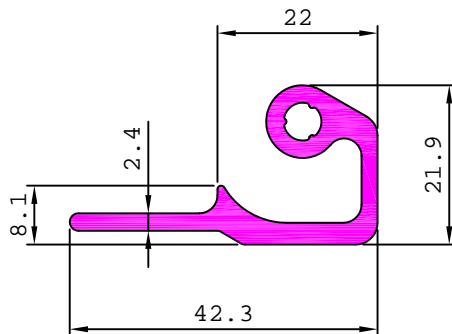

0.632 kg/m

18426

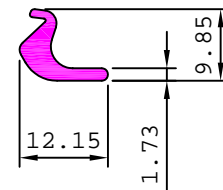

0.118 kg/m

18427

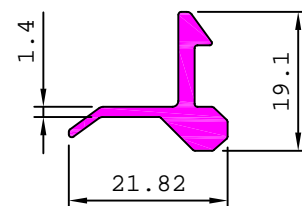

0.250 kg/m

SPECIAL HINGES & ALDROP

38580

0.257 kg/m

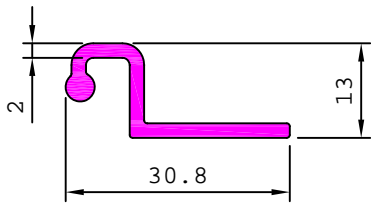

38581

0.450 kg/m

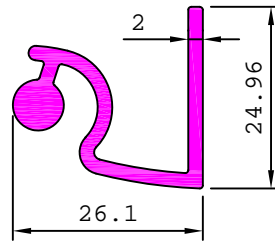

S5062

0.361 kg/m

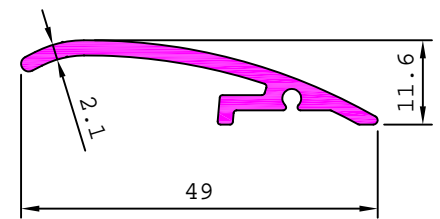

S5061

1.098 kg/m

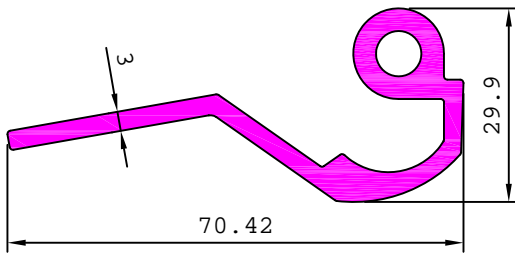

18502

0.832 kg/m

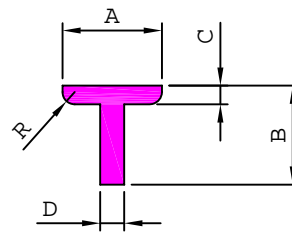
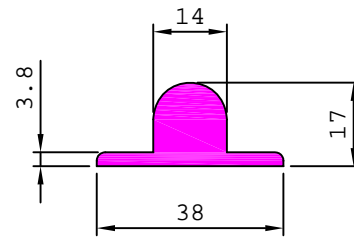

SL. No.	Section No.	A	B	C	D	R	Weight kg/m
1	18504	38.00	35.00	3.20	6.50	3.00	0.875
2	18509	41.50	41.50	3.85	6.80	2.50	1.115
3	18505	41.50	41.50	4.15	7.50	2.50	1.214
4	18508	42.00	38.00	3.25	6.75	2.00	0.997
5	18501	42.00	40.00	4.20	8.00	2.50	1.242

18431

1.878 kg/m

